



## A.HE83146 Introduction

HE83146 is a member of 8-bit Micro-controller series developed by King Billion Electronics Ltd. Users can chose any one of combination among 【1024 dots LCD Driver + 8 Bit I/O Port】...【768 dots LCD Driver + 24 Bit I/O Port】 etc. The 7-bit current-type D/A converter and PWM device provide the complete speech output mechanism. The 192K ROM Size can be used in the storage of speech、graphic、text etc.. It can be applicable to the medium systems such as Small-Scale Dictionary, Data Bank, Pocket Dialer, and Educational Toy etc.

The instruction set of HE83146 are quite easy to learn and simple to use. Only about thirty instructions with four-type addressing mode are provided. Most of instructions take only 3 oscillator clocks (machine cycles). The processing power is enough to most of battery operation system.

## B.HE83146 Feature

- Operation Voltage : 2.2V – 5.5V
- System Clock : DC ~ 8MHz @ 5.0V  
DC ~ 4MHz @ 2.2V
- Internal ROM : 192K Bytes(64K Program ROM+128K Data ROM)
- Internal RAM : 256 Bytes
- Dual Clock System : Normal (Fast) clock : 32.768K ~ 8MHz  
Slow clock : 32.768KHz
- Operation Mode : DUAL、FAST、SLOW、IDLE、SLEEP Mode.
- 8~24 bit Bi-directional I/O port. Mask Option can select PUSH-PULL or OPEN DRAIN output mode for each I/O pin. 8 of them are shared with LCD segment pins.
- 1024~768 dots LCD driver (B TYPE selectable).
- One 7-bit current-type DAC output.



- PWM device.
- Two external interrupts and three internal timer interrupts.
- Two 16-bit timers and one Time-Base timer.
- Instruction set : 32 instructions, 4 addressing mode. 8-bit DATA POINTER for RAM and 18-bit TABLE POINTER for ROM.

## C. HE83146 Application

- Applicable to the medium systems such as Small-Scale Dictionary, Data Bank, Pocket Dialer, Educational Toy, Digital Voice Recording System etc..

## D. Pin Description

Pin #	Pin name	I/O	Function	Description
92	<b>FXI</b> ,	B,	External fast clock pin. Connecting to crystal or RC to generate 32.768 kHz ~ 8MHz frequency.	Mask option setting : MO_FCK/SCKN= 00 : Slow Clock only 01 : Illegal 10 : Dual Clock 11 : Fast Clock only
91	<b>FXO</b>	O		
95	<b>SXI</b> ,	I,	External slow clock pin. Connecting with 32768 Hz crystal or resistor as slow clock and providing clock source for LCD display, TIMER1, Time-Base and other internal blocks.	MO_FOSCE = 0 : Internal fast osc. = 1 : External fast osc. MO_FXTAL = 0 : RC osc. for fast clock = 1 : X'tal osc. for fast clock MO_SXTAL = 0 : RC for 32768 Hz clock = 1 : X'tal for 32768 Hz clock  Use OP1 and OP2 to switch among different operation mode (NORMAL, SLOW, IDEL and SLEEP). In Dual Clock mode, the main system clock is still the Fast Clock. The 32768 Hz clock is for LCD and Timer 1 only.
94	<b>SXO</b>	O		



90	<b>RSTP_N</b>	I	System Reset.	Level trigger, active low. Except for using this pin, using mask option (MO_PORE=1) could enable IC build-in Power-on reset circuit.  Besides, MO_WDTE can set Watch Dog Timer :  MO_WDTE=0 : Disable Watch Dog Timer =1 : Enable Watch Dog Timer
93	<b>TSTP_P</b>	I	Test Pin	Please bond this pin and add a test point on PCB for debugging. Leave this pin floating is OK.
97.. 104	<b>PRTD[7:0]</b>	B	8-pin bi-directional I/O port. PRTD[7..2] as wake-up pin.  PRTD[7..6] as external interrupt pin.	Mask options :  MO_DPP[7..0]=1 ~ Push-pull. =0 ~ Open-drain.  Output must be “1” before reading whenever use them as input (No tri-state structure).
5.. 12	<b>PRT15[7:0]/ SEG[63:56]</b>	B/ O	8-pin bi-directional I/O port that is shared with LCD segment pin.	Mask options :  MO_LIO15[7..0]=1 ~ LCD Pin. =0 ~ I/O Pin.  MO_15PP[7..0]=1 ~ Push-pull. =0 ~ Open-drain.  Output must be “1” before reading whenever use them as input (No tri-state structure).
13.. 20	<b>PRT14[7:0]/ SEG[55:48]</b>	B/ O	8-pin bi-directional I/O port that is shared with LCD segment pin.	Mask options :  MO_LIO14[7..0]=1 ~ LCD Pin. =0 ~ I/O Pin.  MO_14PP[7..0]=1 ~ Push-pull. =0 ~ Open-drain.  Output must be “1” before reading whenever use them as input (No tri-state structure).



4..1 110..			LCD COMmon Output	
107 69.. 76	<b>COM[15:0]</b>	O		LCD Data filled from F0H, please refer the LCD RAM map.
21.. 68	<b>SEG[47:0]</b>	O	LCD SEGment Output	
78	<b>LC2</b>	B	Charge Pump Switch 1	Add one 0.1 $\mu$ F capacitor between LC1 and LC2. Please refer the application circuit.
77	<b>LC1</b>	B	Charge Pump Switch 2	
81	<b>LV3</b>	B	Charge Pump V3	LV3 < 9 Volts.
80	<b>LV2</b>	B	Charge Pump V2	Please refer the application circuit.
79	<b>LV1</b>	B	Charge Pump V1	
82.. 86	<b>LR[4..0]</b>	B	LCD Resister level 4 ~ 1	please refer the application circuit.
87	<b>LVG</b>	I	LCD Virtual Ground	please refer the application circuit.
105	<b>PWMP</b>	O	The PWM positive output can drive speaker or buzzer directly.	Set the bit2 of VOC register as one to turn on PWM.
106	<b>PWMN</b>	O	The PWM positive output can drive speaker or buzzer directly.	Set the bit2 of VOC register as one to turn on PWM.
89	<b>VO</b>	O	DAC Voice Output	Set the bit1(DA=1) of VOC register to turn on DAC with VO output.
96	<b>VDD</b>	P	Positive Power Input	
88	<b>GND</b>	P	Power Ground Input	



## E.LCD RAM Map

Page	SEG	SEG	SEG	SEG	SEG	SEG	SEG	SEG
0	[7:0]	[15:8]	[23:16]	[31:24]	[39:32]	[47:40]	[55:48]	[63:56]
COM0	80H	90H	A0H	B0H	C0H	D0H	E0H	F0H
COM1	81H	91H	A1H	B1H	C1H	D1H	E1H	F1H
COM2	82H	92H	A2H	B2H	C2H	D2H	E2H	F2H
:	:	:	:	:	:	:	:	:
:	:	:	:	:	:	:	:	:
COM13	8DH	9DH	ADH	BDH	CDH	DDH	EDH	FDH
COM14	8EH	9EH	AEH	BEH	CEH	DEH	EEH	FEH
COM15	8FH	9FH	AFH	BFH	CFH	DFH	EFH	FFH





## G. Bonding Pad Location

PIN Number	PIN Name	X Coordinate	Y Coordinate	PIN Number	PIN Name	X Coordinate	Y Coordinate
1	COM[12]	X= -1657.05	Y= 1500.75	56	SEG[12]	X= 1656.70	Y= -1502.25
2	COM[13]	X= -1657.05	Y= 1385.25	57	SEG[11]	X= 1656.70	Y= -1386.75
3	COM[14]	X= -1657.05	Y= 1269.75	58	SEG[10]	X= 1656.70	Y= -1271.25
4	COM[15]	X= -1657.05	Y= 1154.25	59	SEG[9]	X= 1656.70	Y= -1155.75
5	PRT15[7]	X= -1657.05	Y= 1038.75	60	SEG[8]	X= 1656.70	Y= -1040.25
6	PRT15[6]	X= -1657.05	Y= 923.25	61	SEG[7]	X= 1656.70	Y= -924.75
7	PRT15[5]	X= -1657.05	Y= 807.75	62	SEG[6]	X= 1656.70	Y= -809.25
8	PRT15[4]	X= -1657.05	Y= 692.25	63	SEG[5]	X= 1656.70	Y= -693.75
9	PRT15[3]	X= -1657.05	Y= 576.75	64	SEG[4]	X= 1656.70	Y= -578.25
10	PRT15[2]	X= -1657.05	Y= 461.25	65	SEG[3]	X= 1656.70	Y= -462.75
11	PRT15[1]	X= -1657.05	Y= 345.75	66	SEG[2]	X= 1656.70	Y= -347.25
12	PRT15[0]	X= -1657.05	Y= 230.25	67	SEG[1]	X= 1656.70	Y= -231.75
13	PRT14[7]	X= -1657.05	Y= 114.75	68	SEG[0]	X= 1656.70	Y= -116.25
14	PRT14[6]	X= -1657.05	Y= -0.75	69	COM[7]	X= 1656.70	Y= -0.75
15	PRT14[5]	X= -1657.05	Y= -116.25	70	COM[6]	X= 1656.70	Y= 114.75
16	PRT14[4]	X= -1657.05	Y= -231.75	71	COM[5]	X= 1656.70	Y= 230.25
17	PRT14[3]	X= -1657.05	Y= -347.25	72	COM[4]	X= 1656.70	Y= 345.75
18	PRT14[2]	X= -1657.05	Y= -462.75	73	COM[3]	X= 1656.70	Y= 461.25
19	PRT14[1]	X= -1657.05	Y= -578.25	74	COM[2]	X= 1656.70	Y= 576.75
20	PRT14[0]	X= -1657.05	Y= -693.75	75	COM[1]	X= 1656.70	Y= 692.25
21	SEG[47]	X= -1657.05	Y= -809.25	76	COM[0]	X= 1656.70	Y= 807.75
22	SEG[46]	X= -1657.05	Y= -924.75	77	LC1	X= 1656.70	Y= 923.25



23	SEG[45]	X= -1657.05	Y= -1040.25	78	LC2	X= 1656.70	Y= 1038.75
24	SEG[44]	X= -1657.05	Y= -1155.75	79	LV1	X= 1656.70	Y= 1154.25
25	SEG[43]	X= -1657.05	Y= -1271.25	80	LV2	X= 1656.70	Y= 1269.75
26	SEG[42]	X= -1657.05	Y= -1386.75	81	LV3	X= 1656.70	Y= 1385.25
27	SEG[41]	X= -1657.05	Y= -1502.25	82	LR4	X= 1656.70	Y= 1500.75
28	SEG[40]	X= -1559.10	Y= -1710.30	83	LR3	X= 1599.95	Y= 1797.10
29	SEG[39]	X= -1443.60	Y= -1710.30	84	LR2	X= 1484.45	Y= 1797.10
30	SEG[38]	X= -1328.10	Y= -1710.30	85	LR1	X= 1368.95	Y= 1797.10
31	SEG[37]	X= -1212.60	Y= -1710.30	86	LR0	X= 1253.45	Y= 1797.10
32	SEG[36]	X= -1097.10	Y= -1710.30	87	LVG	X= 1137.95	Y= 1797.10
33	SEG[35]	X= -981.60	Y= -1710.30	88	GND	X= 1022.45	Y= 1797.10
34	SEG[34]	X= -866.10	Y= -1710.30	89	VO	X= 906.95	Y= 1797.10
35	SEG[33]	X= -750.60	Y= -1710.30	90	RSTP_N	X= 791.45	Y= 1797.10
36	SEG[32]	X= -635.10	Y= -1710.30	91	FXO	X= 675.95	Y= 1797.10
37	SEG[31]	X= -519.60	Y= -1710.30	92	FXI	X= 560.45	Y= 1797.10
38	SEG[30]	X= -404.10	Y= -1710.30	93	TSTP_P	X= 444.95	Y= 1797.10
39	SEG[29]	X= -288.60	Y= -1710.30	94	SXO	X= 329.45	Y= 1797.10
40	SEG[28]	X= -173.10	Y= -1710.30	95	SXI	X= 213.95	Y= 1797.10
41	SEG[27]	X= -57.60	Y= -1710.30	96	VDD	X= 98.45	Y= 1797.10
42	SEG[26]	X= 57.90	Y= -1710.30	97	PRTD[7]	X= -17.05	Y= 1797.10
43	SEG[25]	X= 173.40	Y= -1710.30	98	PRTD[6]	X= -132.55	Y= 1797.10
44	SEG[24]	X= 288.90	Y= -1710.30	99	PRTD[5]	X= -248.05	Y= 1797.10
45	SEG[23]	X= 404.40	Y= -1710.30	100	PRTD[4]	X= -363.55	Y= 1797.10
46	SEG[22]	X= 519.90	Y= -1710.30	101	PRTD[3]	X= -479.05	Y= 1797.10
47	SEG[21]	X= 635.40	Y= -1710.30	102	PRTD[2]	X= -594.55	Y= 1797.10
48	SEG[20]	X= 750.90	Y= -1710.30	103	PRTD[1]	X= -710.05	Y= 1797.10
49	SEG[19]	X= 866.40	Y= -1710.30	104	PRTD[0]	X= -825.55	Y= 1797.10
50	SEG[18]	X= 981.90	Y= -1710.30	105	PWMP	X= -965.30	Y= 1797.10





51	SEG[17]	X= 1097.40	Y= -1710.30	106	PWMN	X= -1128.65	Y= 1797.10
52	SEG[16]	X= 1212.90	Y= -1710.30	107	COM[8]	X= -1267.75	Y= 1797.10
53	SEG[15]	X= 1328.40	Y= -1710.30	108	COM[9]	X= -1383.25	Y= 1797.10
54	SEG[14]	X= 1443.90	Y= -1710.30	109	COM[10]	X= -1498.75	Y= 1797.10
55	SEG[13]	X= 1559.40	Y= -1710.30	110	COM[11]	X= -1614.25	Y= 1797.10

## H. DC/AC Characteristics

### Absolute Maximum Rating

Item	Sym.	Rating	Condition
Supply Voltage	$V_{dd}$	-0.5V ~ 8V	
Input Voltage	$V_{in}$	-0.5V ~ $V_{dd}+0.5V$	
Output Voltage	$V_o$	-0.5V ~ $V_{dd}+0.5V$	
Operating Temperature	$T_{op}$	0°C ~ 70°C	
Storage Temperature	$T_{st}$	-50°C ~ 100°C	

### Recommended Operating Conditions

Item	Sym.	Rating	Condition
Supply Voltage	$V_{dd}$	2.2V ~ 5.5V	
Input Voltage	$V_{ih}$	0.9 $V_{dd}$ ~ $V_{dd}$	
	$V_{il}$	0.0V ~ 0.1 $V_{dd}$	
Operating Frequency	$F_{max}$	8MHz	$V_{dd} = 5.0V$
		4MHz	$V_{dd} = 2.2V$
Operating Temperature	$T_{op}$	0°C ~ 70°C	
Storage Temperature	$T_{st}$	-50°C ~ 100°C	



Testing Condition : TEMP=25°C, VDD=3V+/-10%, GND=0V

	PARAMETER		CONDITION	MIN	TYP	MAX	UNIT
I <sub>Fast</sub>	NORMAL Mode Current	System	2M ext. R/C		0.75	1	mA
I <sub>Slow</sub>	SLOW Mode Current	System	32.768K X'tal LCD Disable		10	20	μA
I <sub>Idle</sub>	IDLE Mode Current	System	32.769K X'tal LCD Disable		6	10	μA
I <sub>LCD</sub>	Extra Current if LCD ON	System	LCD Enable, LCD option=300Kohm Voltage-doubler OFF		12	20	μA
			LCD Enable, LCD option=30Kohm, Voltage-doubler ON		100	120	
I <sub>Sleep</sub>	Sleep Mode Current	System				1	μA
I <sub>oHPWM</sub>	PWM Output Drive Current	PWMP, PWMN*2	V <sub>DD</sub> =3V; V <sub>oh</sub> =2V	12	15		mA
I <sub>oLPWM</sub>	PWM Output Sink Current	PWMP, PWMN*2	V <sub>DD</sub> =3V; V <sub>oL</sub> =1V	33	40		mA
I <sub>oVO</sub>	DAC Output Current	VO	V <sub>DD</sub> =3V; VO=0~2V, Data=7F	2.5	3		mA
V <sub>iH</sub>	Input High Voltage	I/O pins		0.8 V <sub>DD</sub>			V
V <sub>iL</sub>	Input Low Voltage	I/O pins				0.2 V <sub>DD</sub>	V
V <sub>hys</sub>	Input Hysteresis Width	I/O, RSTP_N	Threshold=2/3V <sub>DD</sub> (input from low to high) Threshold=1/3V <sub>DD</sub> (input from high to low)		1/3 V <sub>DD</sub>		V
I <sub>oH</sub>	Output Drive Current	I/O pull-high*1	V <sub>oL</sub> =2.0V	50			μA
I <sub>oL_1</sub>	Output Sink Current	I/O pull-low*1	V <sub>oL</sub> =0.4V	1.0			mA
I <sub>iL_1</sub>	Input Low Current	RSTP_N	V <sub>iL</sub> =GND, pull high Internally		20		μA
I <sub>iL_2</sub>	Input Low Current	I/O	V <sub>iL</sub> =GND, if pull high Internally by user		100		μA

Note: \*1: Drive Current Spec. for Push-Pull I/O port only  
 Sink Current Spec. for both Push-Pull and Open-Drain I/O port.

\*2: This Spec. base on one driver only. There are five build-in driver, so user just multiply the number of driver he used to one driver current to get the total amount of current. ( $I_{oHPWM}$ 、 $I_{oLPWM}$  \* N; N=0,1,2,3,4,5)

# I. Application Circuit

Triple Charge Pump is selected LCD Max. Voltage=LV3=3\*VDD    Triple Charge Pump is selected LCD Max. Voltage=LV3=3/2\*VDD    Triple Charge Pump is selected LCD Max. Voltage=LV3=VDD

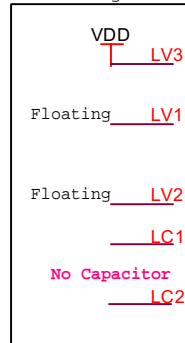
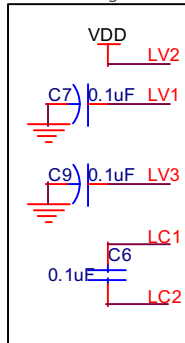
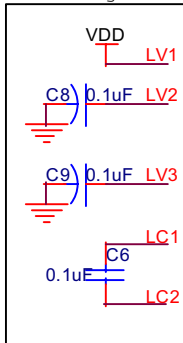

No External Parts is necessary if user adopt Internal Fast RC Clock

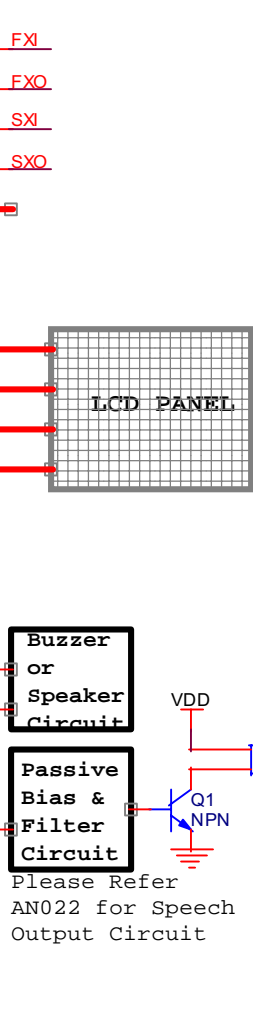
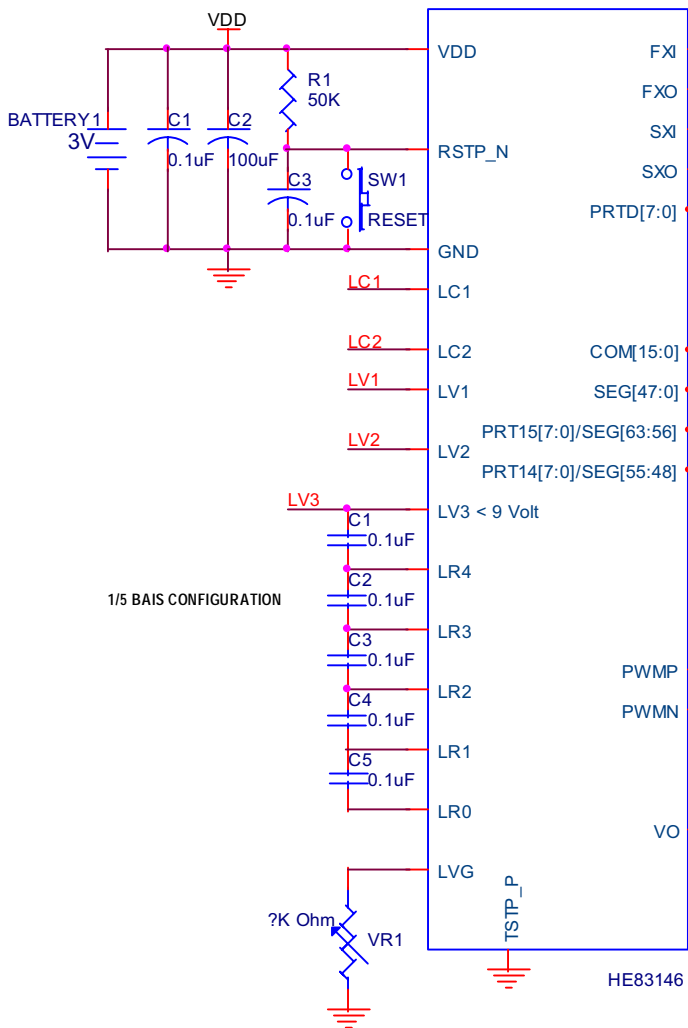

External Fast Clock: Crystal osc.

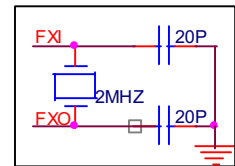

External Fast Clock: RC osc.

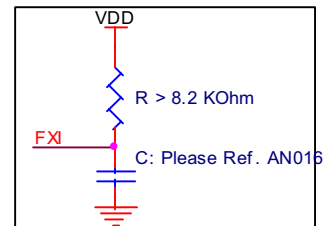

External Slow Clock: Crystal osc.

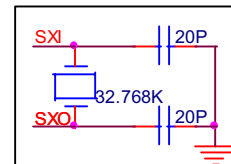

External Slow Clock: RC osc.

